

# MULTICOAT POST FLASHING & REGLET DETAIL

NOT TO SCALE

\* NOTE: For installation instructions please refer to the system specification sheets posted on our website.

## NOTES:

- APPLY POLYURETHANE CAULKING ON ALL FLASHING SEAMS AND OVERLAPS. STANDARD OVERLAP IS BOTTOM TO TOP WITH A 4" OVERLAP.
- 2500 PSI MINIMUM FOR CONCRETE SUBSTRATES
- 5/8" EXTERIOR GRADE MINIMUM FOR PLYWOOD SUBSTRATE
- 1/4" MINIMUM SLOPE REQUIRED ON ALL DECKS
- REFER TO LOCAL BUILDING CODES & STANDARDS

### SITE BUILT REGLET

V-CUTS

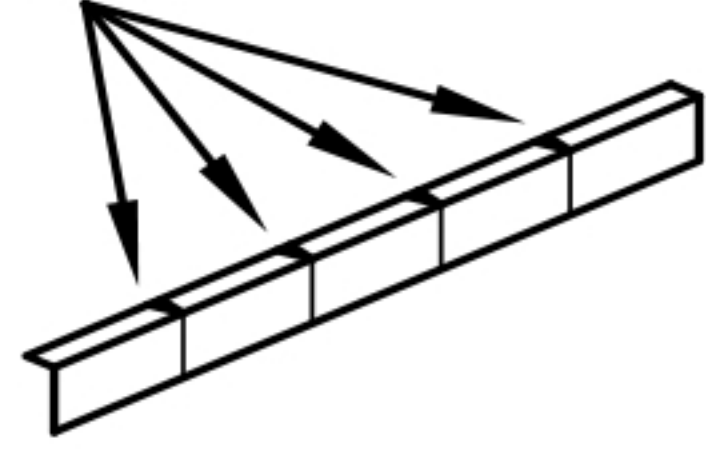

FOLD ALONG VERTICAL LINES (2 SIDES WILL OVERLAP)

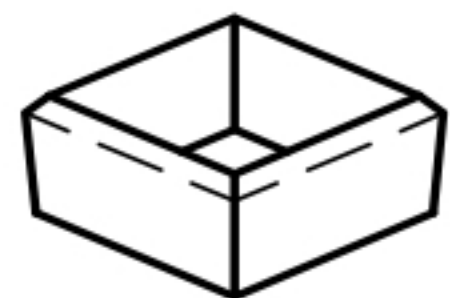
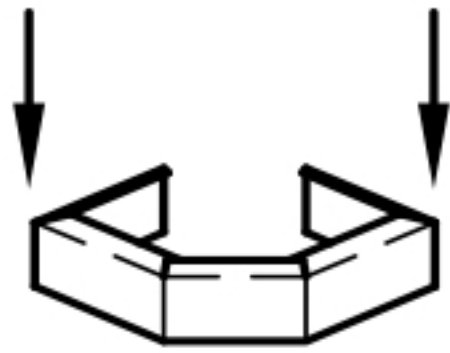

FINISHED FORM

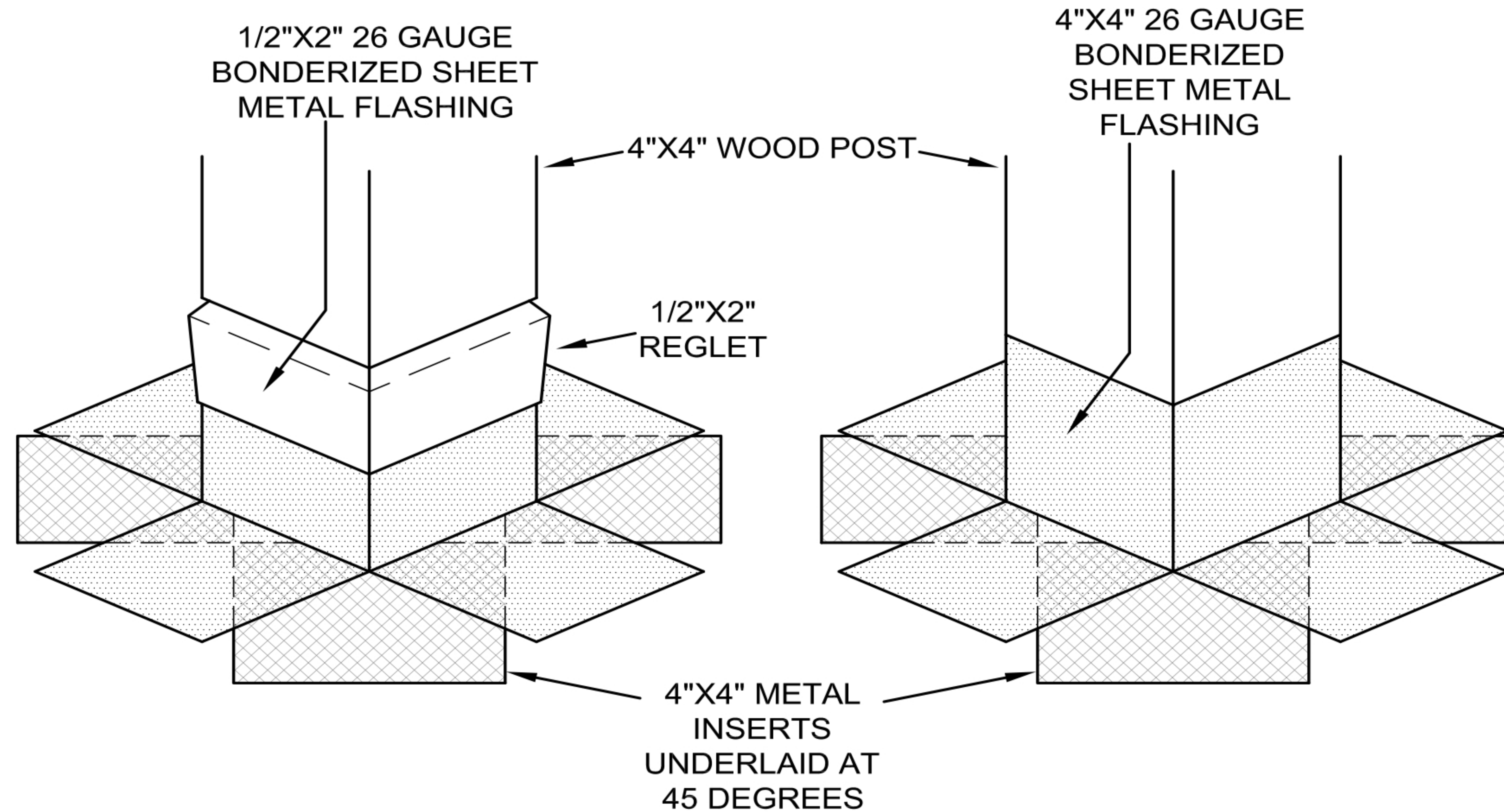

### SITE BUILT FLASHING

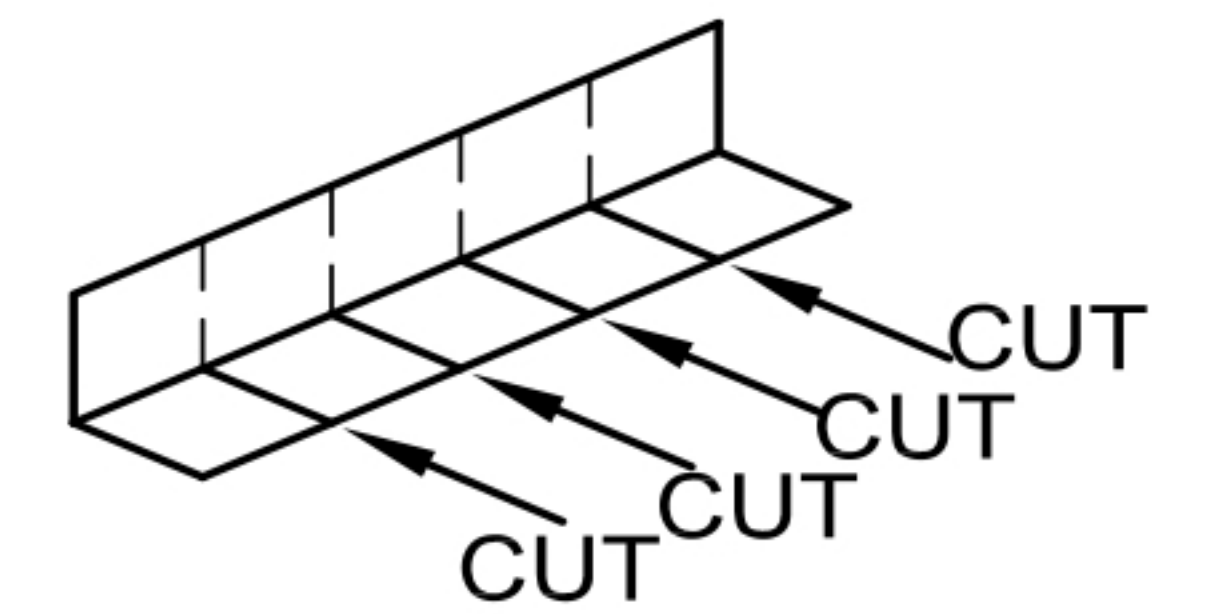

FOLD AT EA. VERTICAL LINE (2 SIDES WILL OVERLAP)

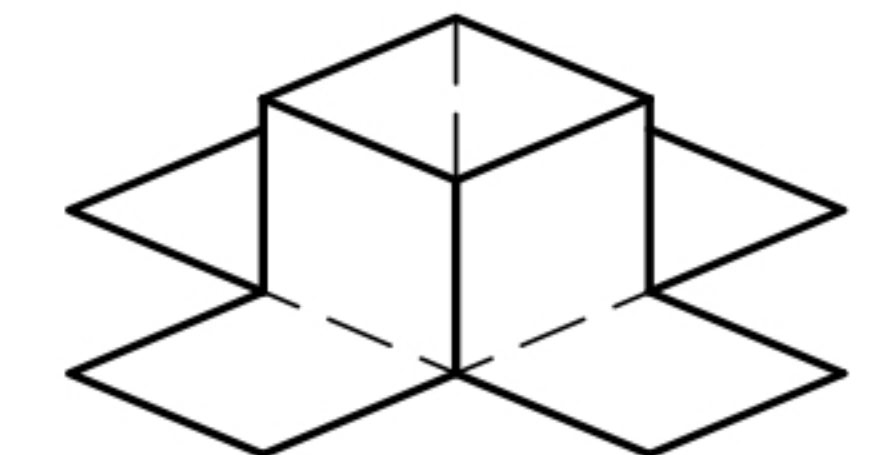
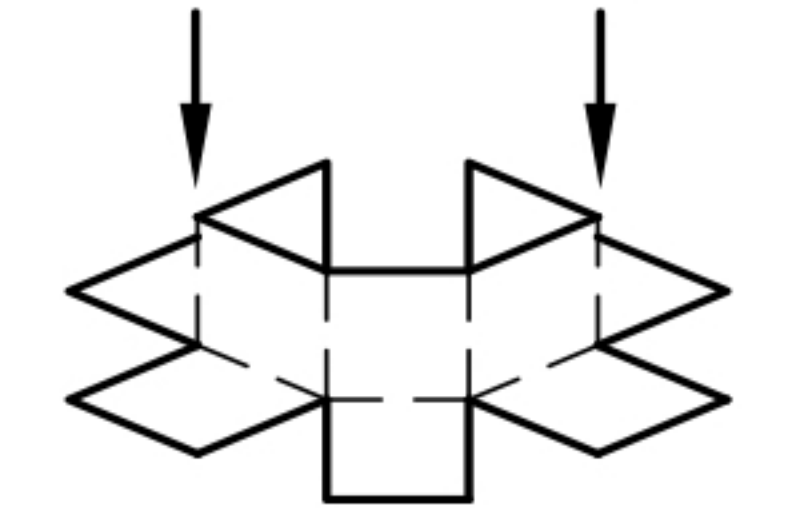

FINISHED FORM

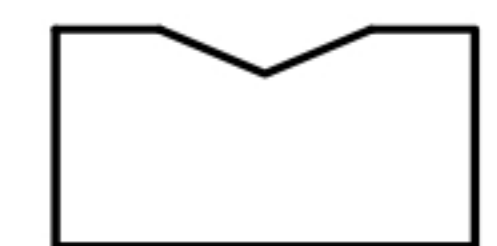

INSERT

23331 ANTONIO PARKWAY  
RANCHO SANTA MARGARITA CA 92679



WWW.MULTICOAT.COM  
(877)-685-8426